



Secret Fix-H

Technical section

Secret Fix

Undercut Anchor System, SF horizontal rail system and SF hanger clasps allow supporting of light to heavy weight facades.

Secret Fix-L is designed for invisible mounting of facade materials with a thickness of 8mm to 25mm.

Secret Fix-H is designed for invisible mounting of facade materials with a thickness greater than 25mm.

The SF clasps are supplied in 40, 50 & 80mm widths based on loading requirements. RJ Facades technical department will specify the hanger brackets depending on the facade panel size and weight.

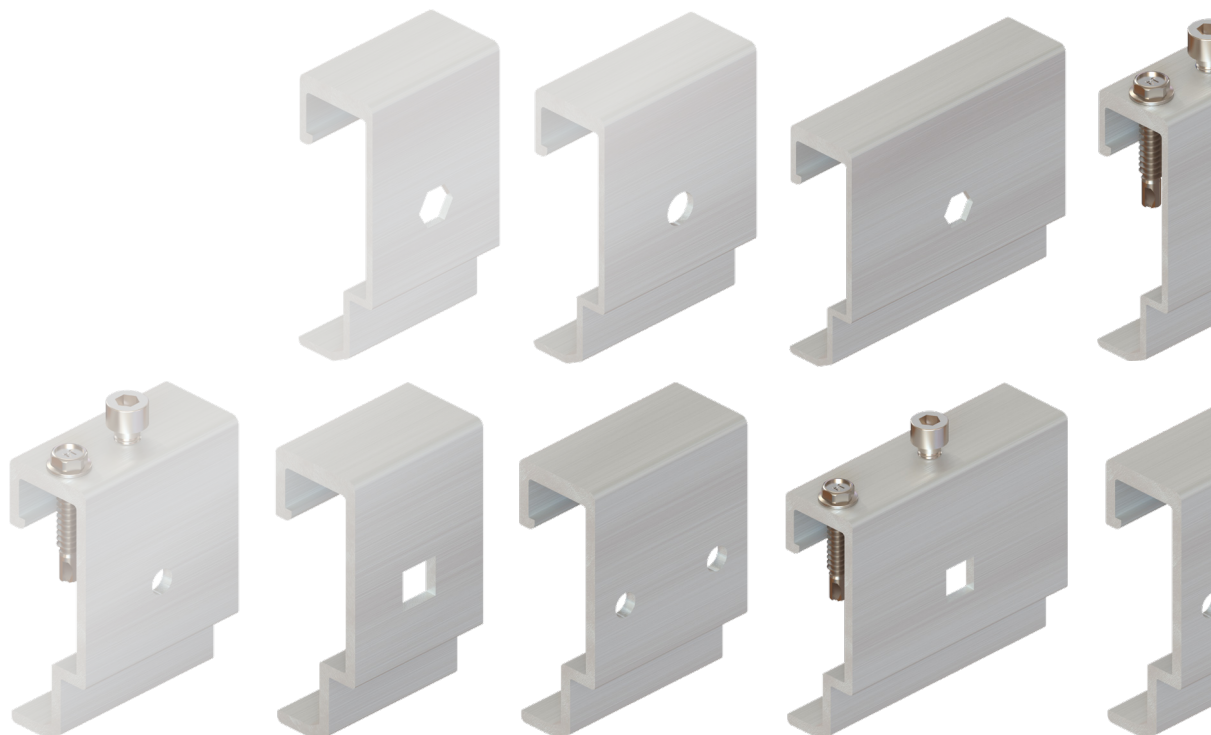

Designed for all market leading undercut fixing configurations. SF hangers are available with a variety of hole geometry to suit various methods for secret fixing to different facade types, including Fischer FZP, Keil, SFS and other projecting bolts.

The majority of facades can be designed using 2mm vertical sections, although there structurally required 3mm sections are specified. Bracket and profile configuration is specified by RJ Facades technical department.

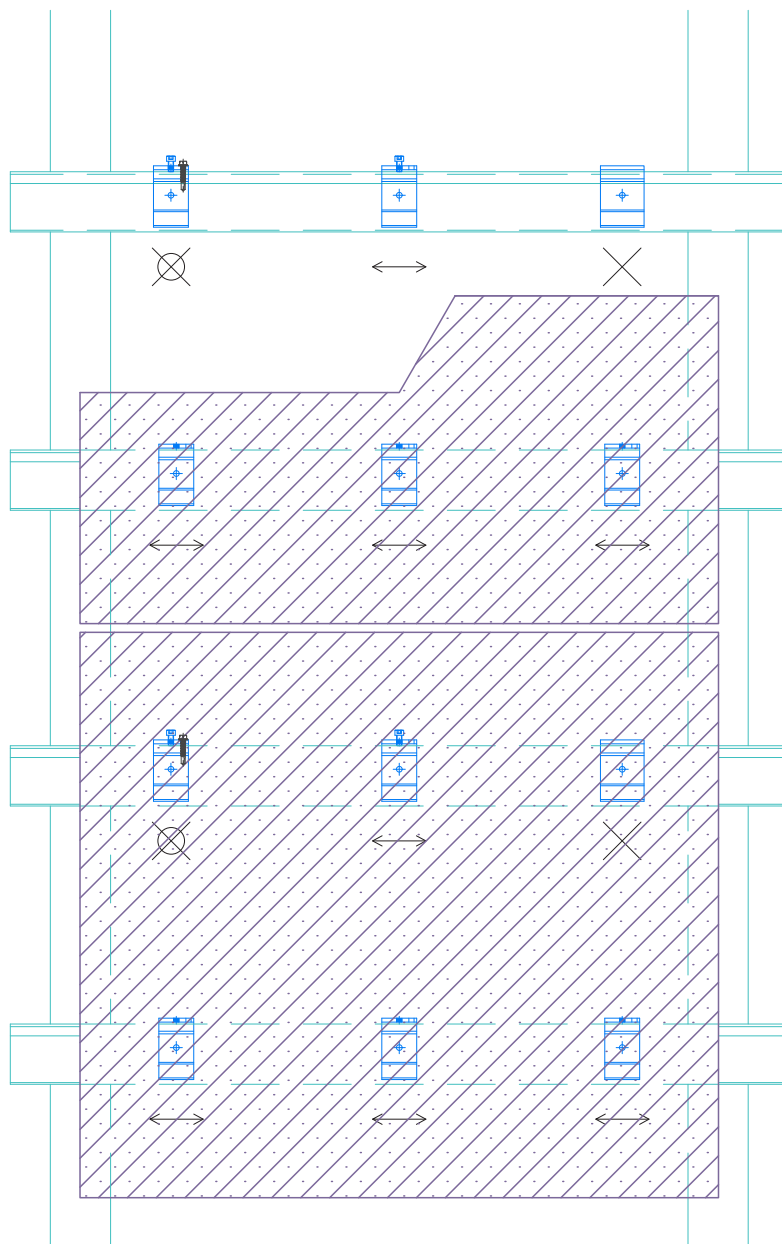

Secret Fix - Clasp Positioning



	Secured fixed point (Secured to horizontal profile with JT4-4-4.8 x 19)
	Fixed point
	Sliding Point

Secret Fix - Aluminium, Horizontal Support Rail

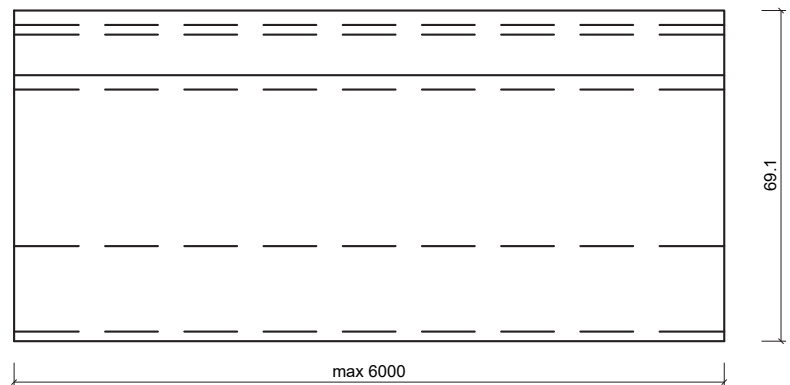
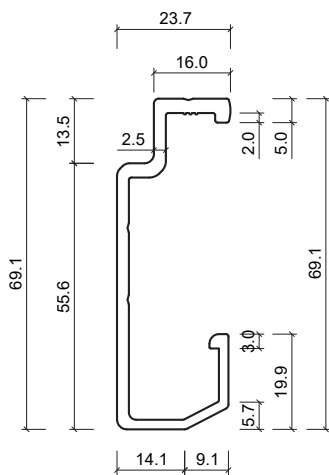

Item	Material
Secret Fix Rail	Aluminum - EN AW 6063 T6

All measurements in mm*

Secret Fix - Cladding Zone

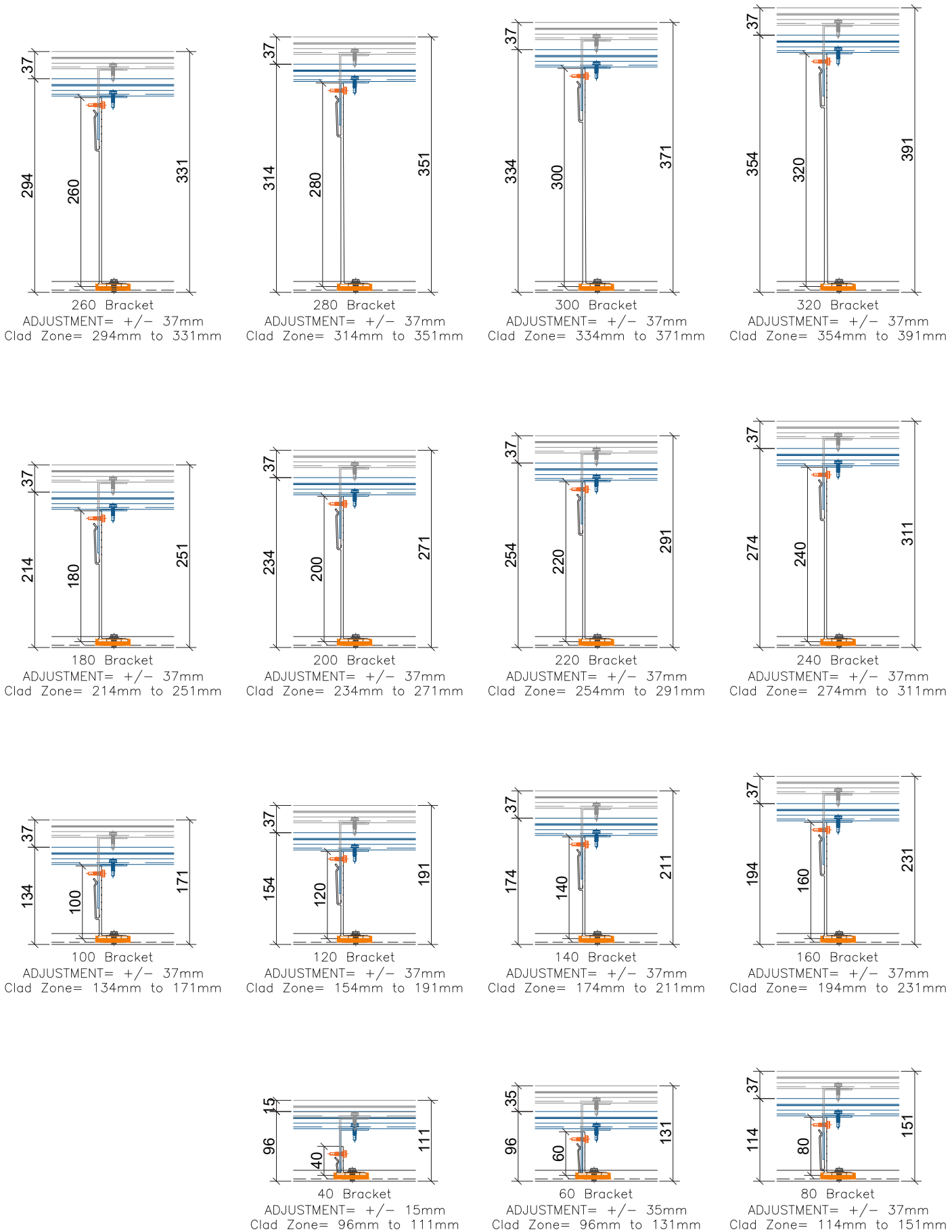

Secret Fix-H

Undercut Anchor System, SF horizontal rail system and SF2 hanger clasps to support medium to heavy weight facades. Secret Fix-H is designed for invisible mounting of thin and smooth facade materials.

System accessories and designed profiles allow secure mounting of facades, including stone up to 50mm in thickness.

Secret Fix-H System uses fixing anchors to guarantee the connections between the facade material and the main profiles of the system.

Main advantages:

- | SF2 clasps designed to 'help' the connection to the SF horizontal profile.
- | Perfect vision of the facade with no visible holding elements.
- | Large variety of sizes and designs of the facade materials.
- | Highest level of security when fixing the tiles, due to the undercut anchors.
- | Possibility to use facade materials with thickness ranging from 25mm to over 35mm.
- | Fast and easy installation compared to other secret fix systems.
- | Secure and fully engineered work, which covers the entire project, and guarantees a complete system solution Cladding Materials.
- | Use of stand off fixings with natural stone panels to remove thickness tolerances.

Typical Cladding Materials



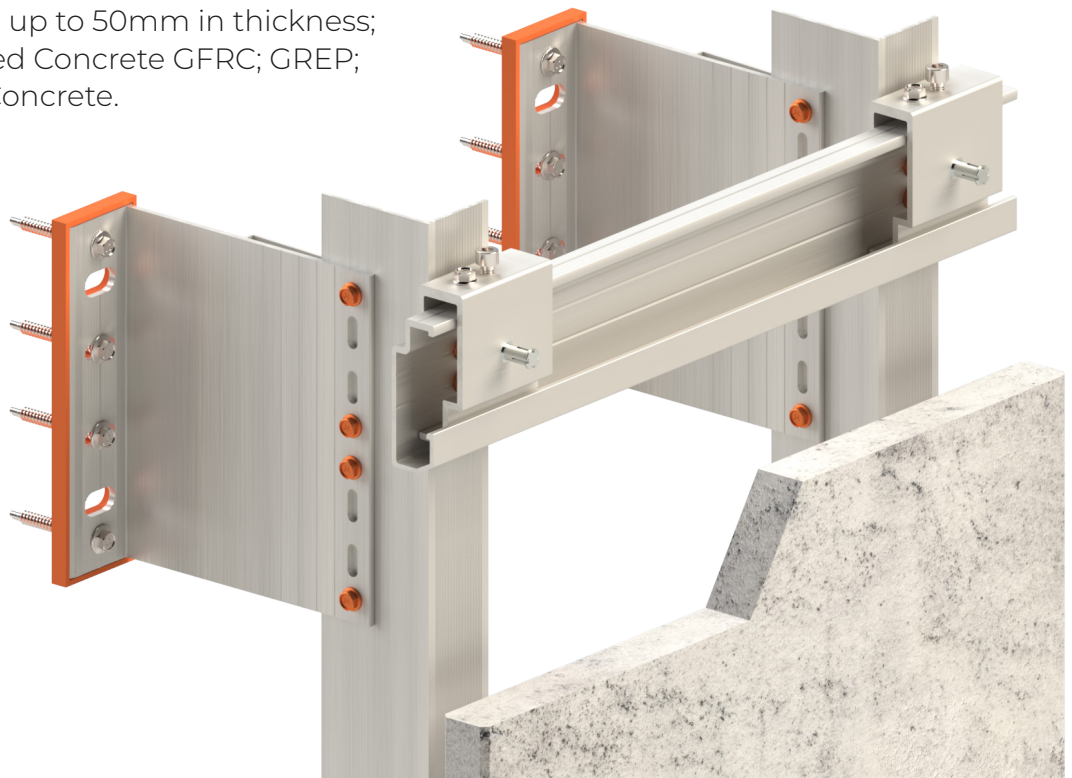

- | Technical Stone; Ceramic Tiles; Glass; Fibre Cement; Stone; Natural Stone up to 50mm in thickness; Glass Fiber Reinforced Concrete GFRC; GREP; Light Transmitting Concrete.

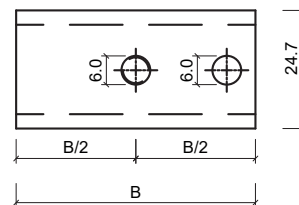
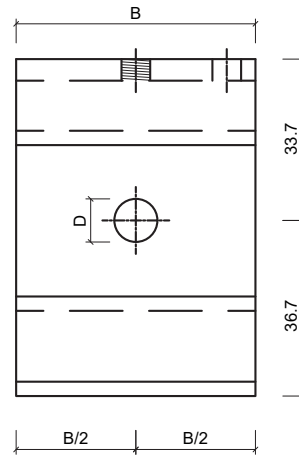
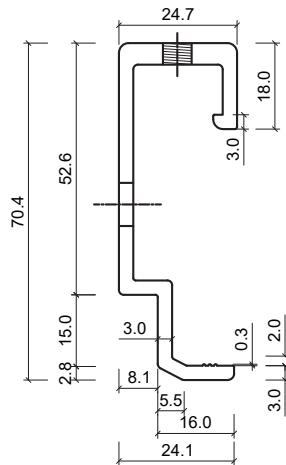

Secret Fix-H - Aluminium, Fixed Point Clasp



Item	Material
Secret Fix Rail	Aluminum - EN AW 6063 T6



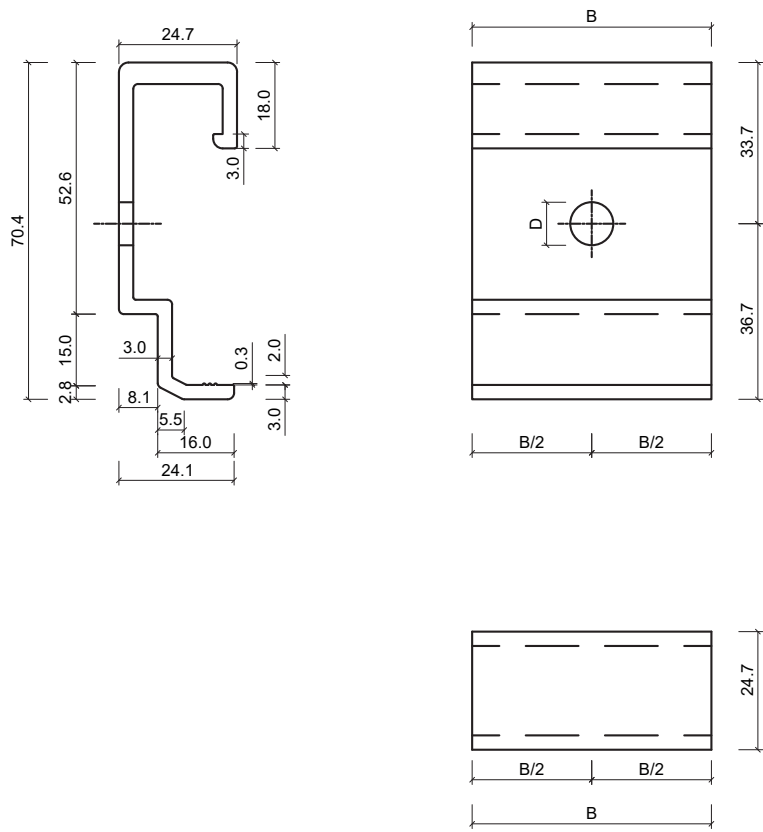

D	Fixing Configuration
	Hex
	Square
	M6
	M8

All measurements in mm*

Secret Fix-H - Aluminium, Sliding Point Clasp



Item	Material
Secret Fix Rail	Aluminum - EN AW 6063 T6

D	Fixing Configuration
 10.7	Hex
 10.3	Square
 6.6	M6
 9.0	M8

All measurements in mm*

Secret Fix-H

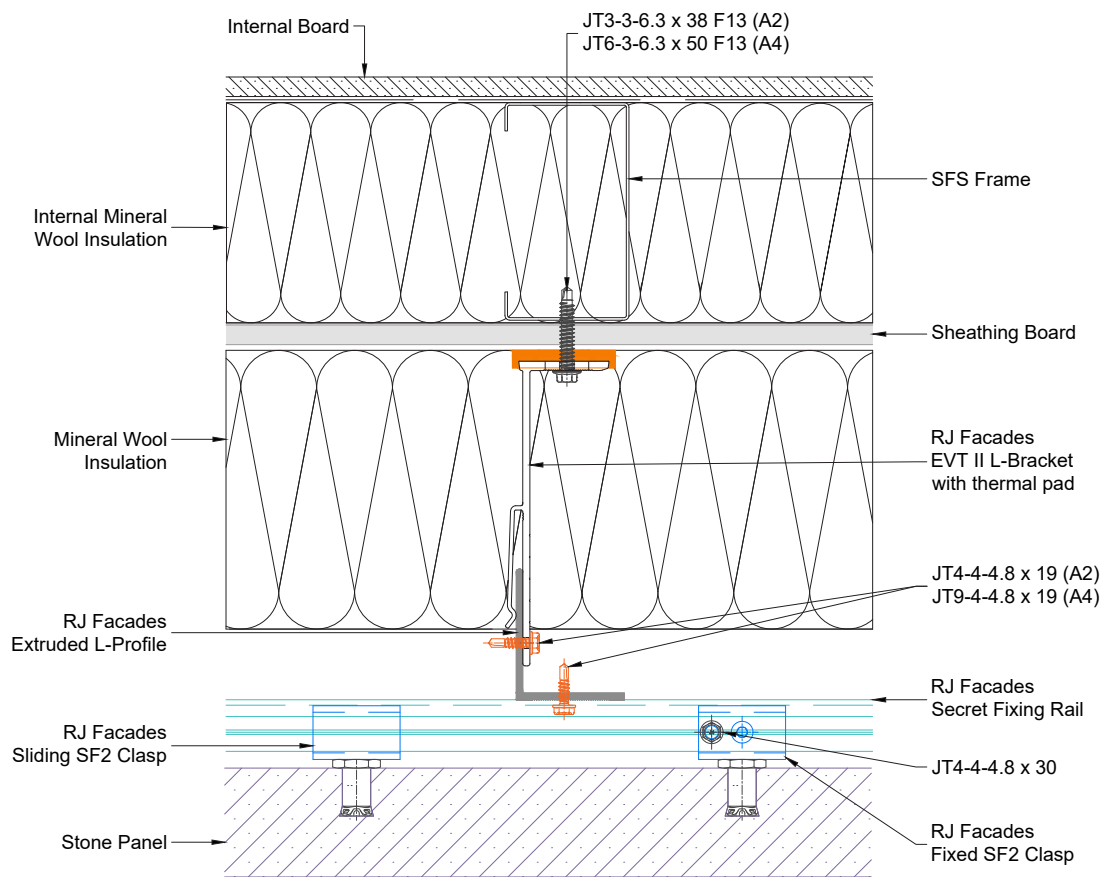

Secret Fix-H

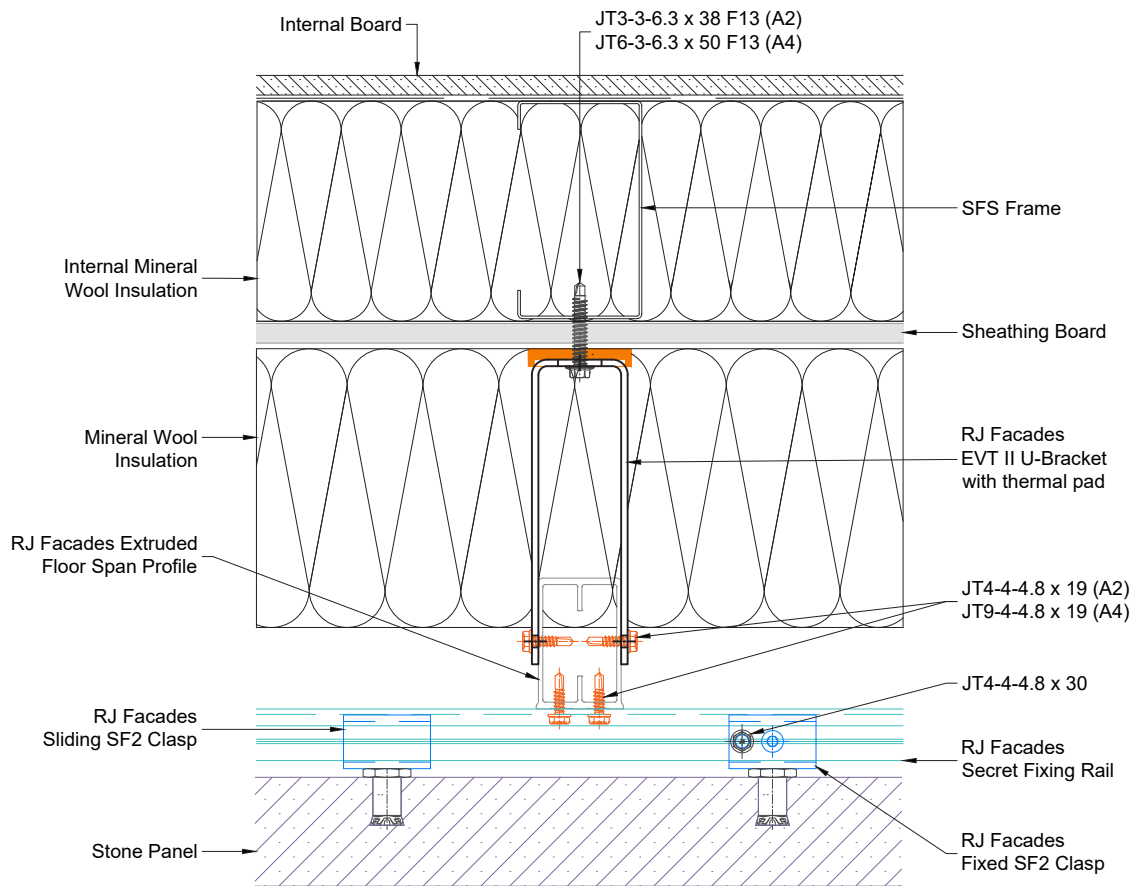

Secret Fix-H

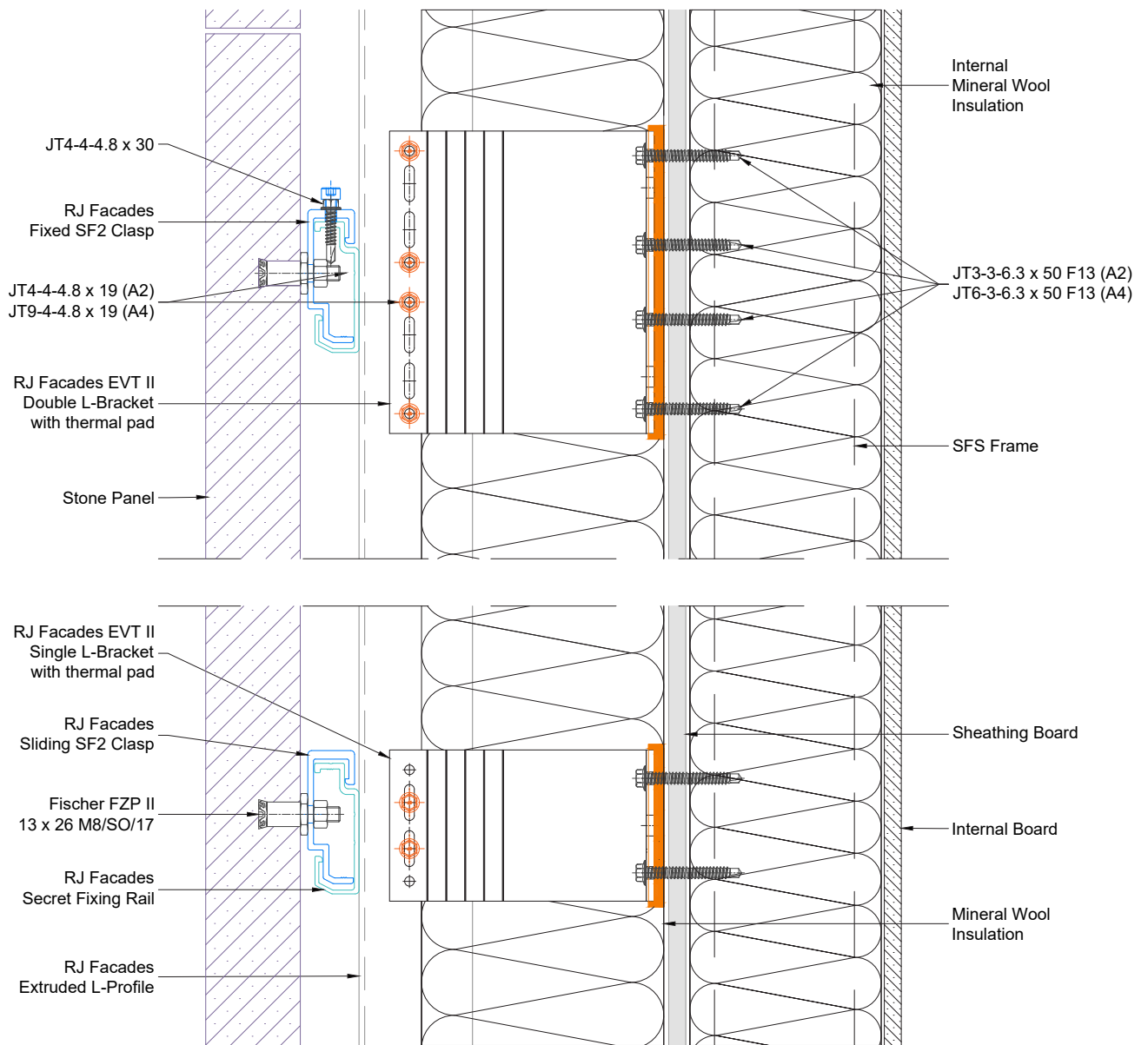

Secret Fix-H

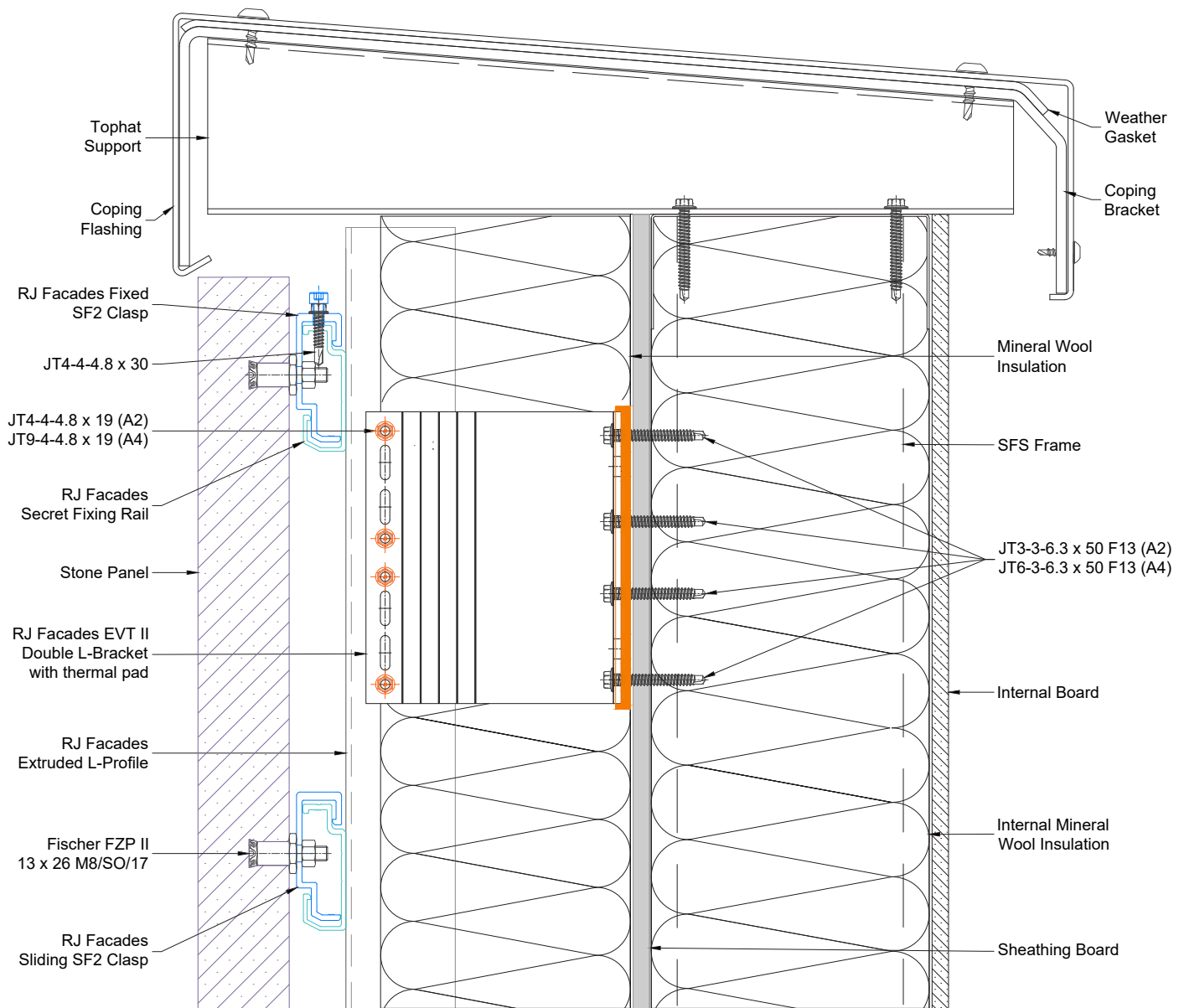

Secret Fix-H

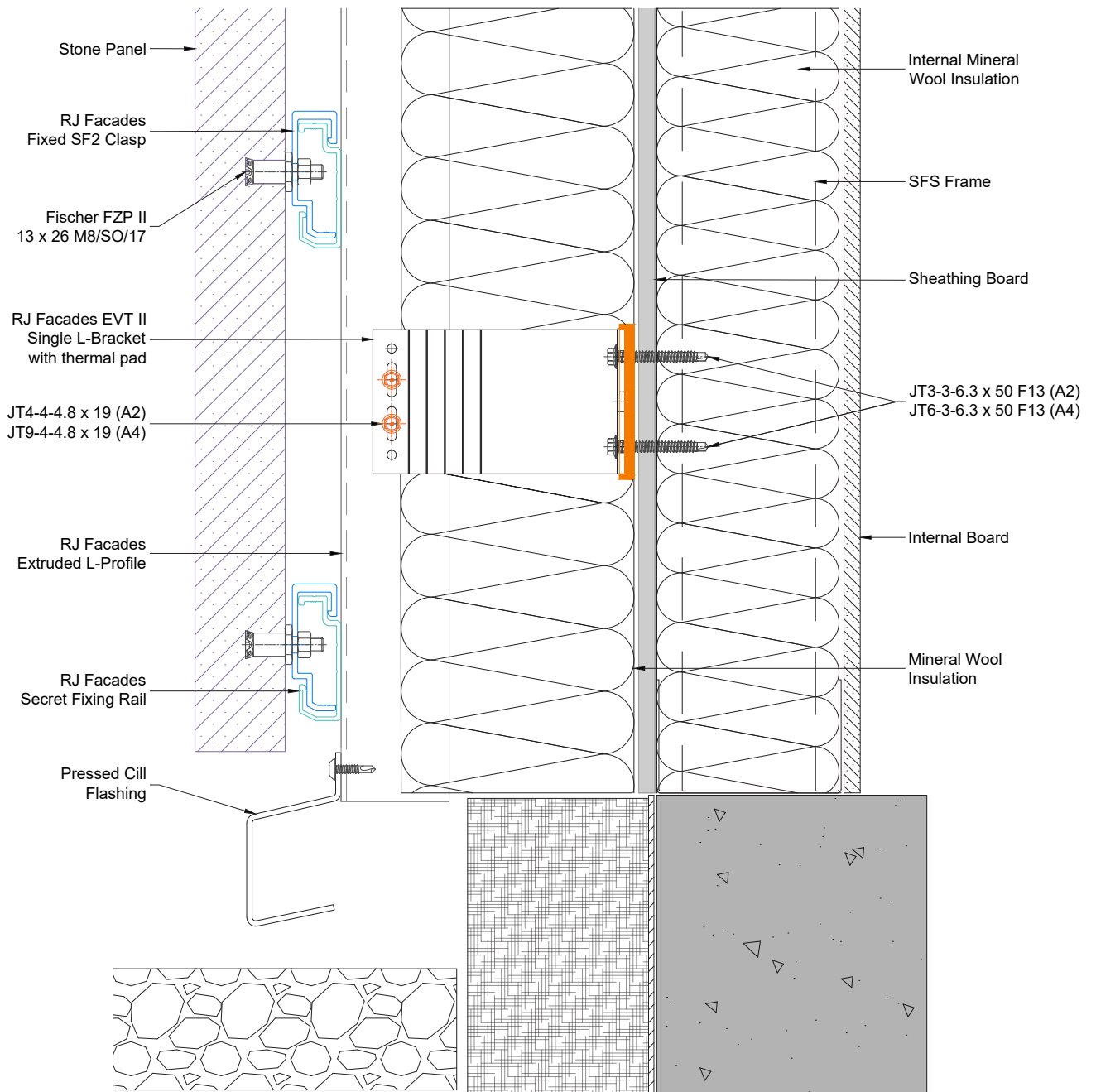

Secret Fix-H

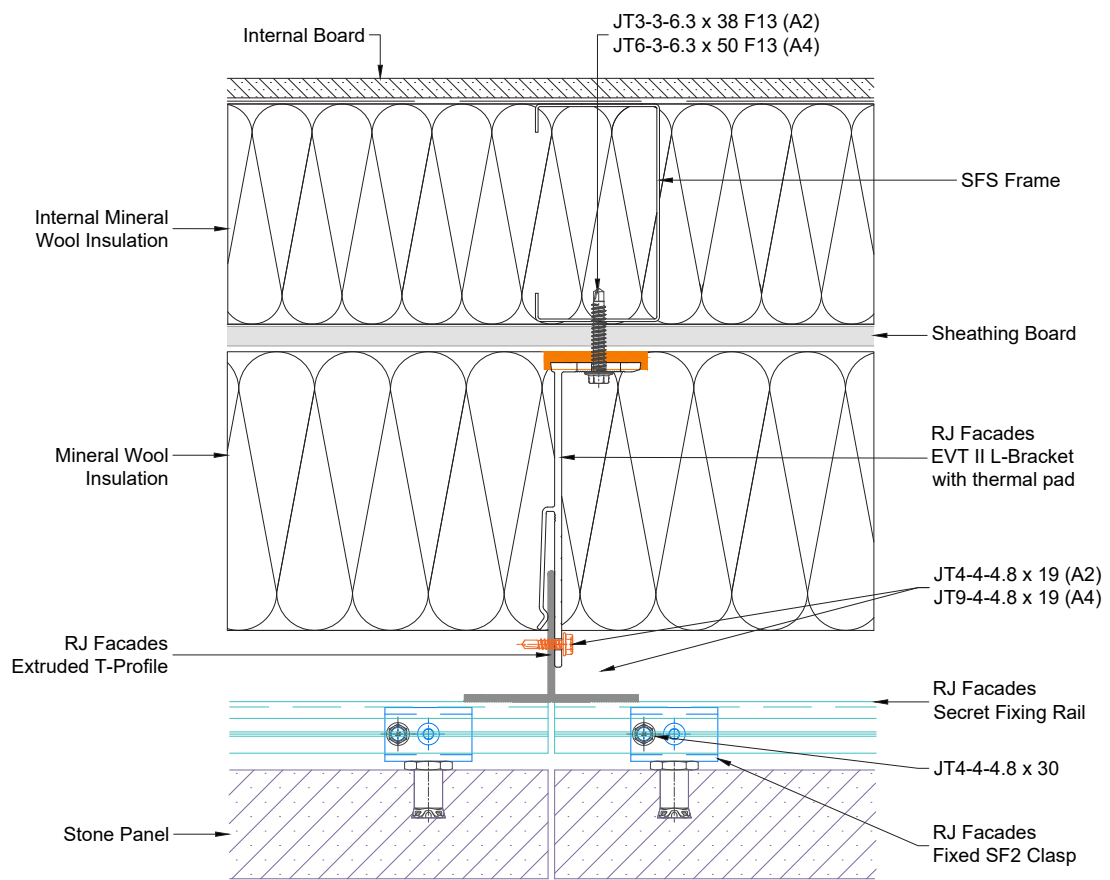

Secret Fix-H

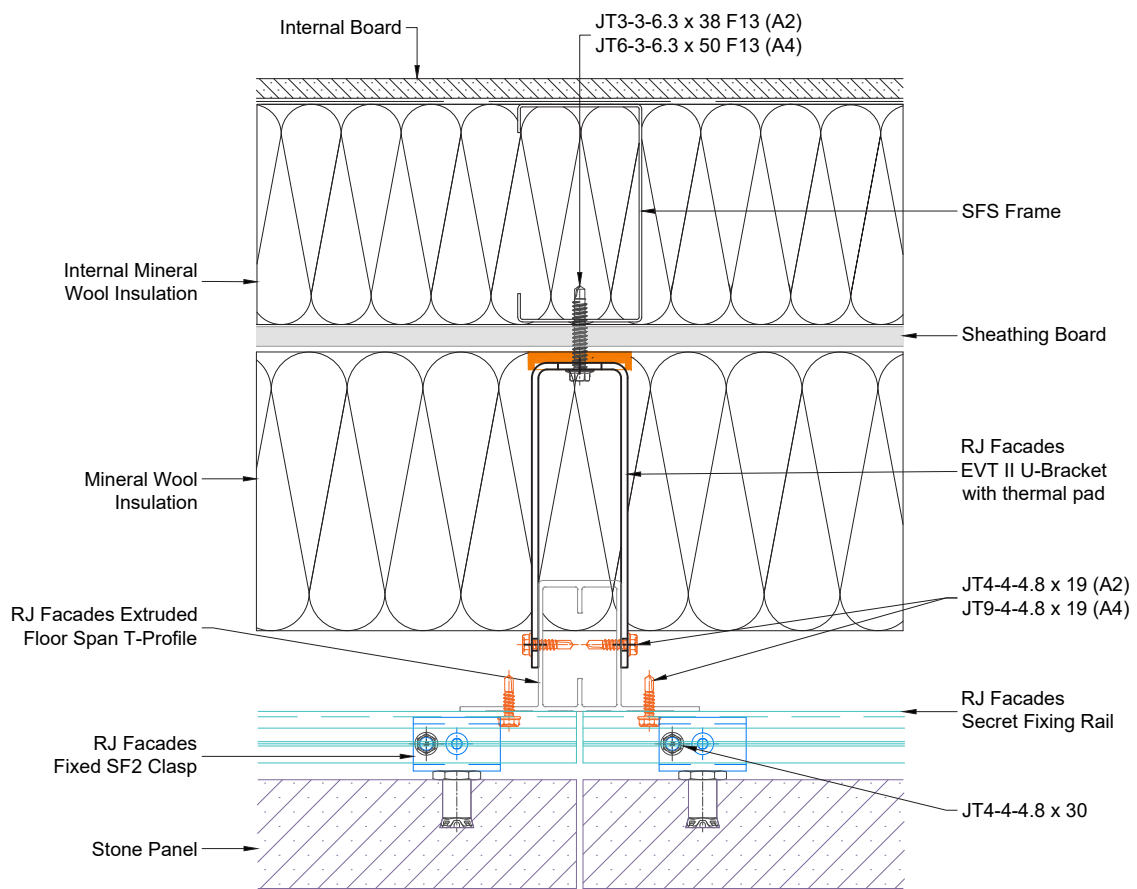

Secret Fix-H

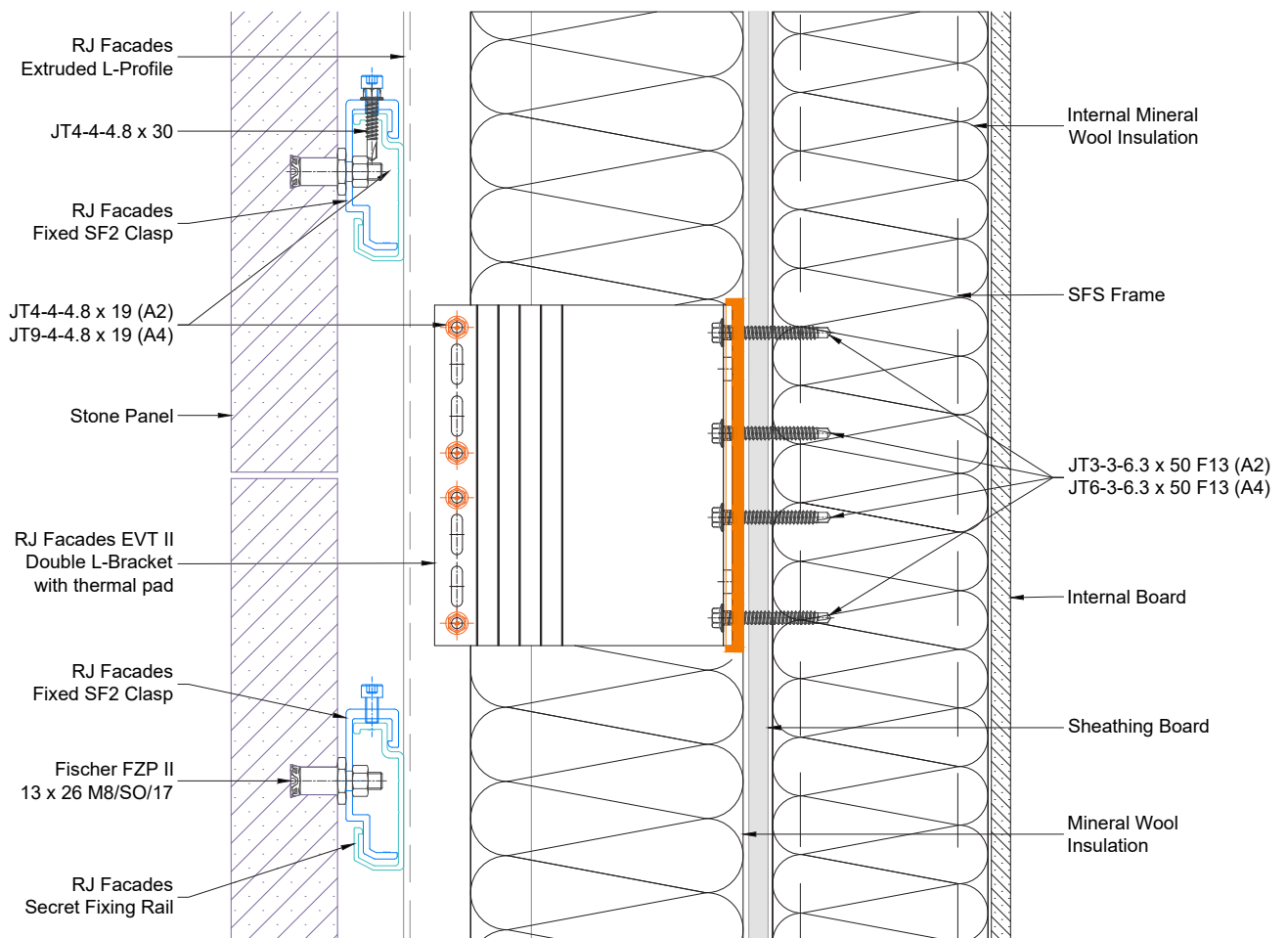

Secret Fix-H

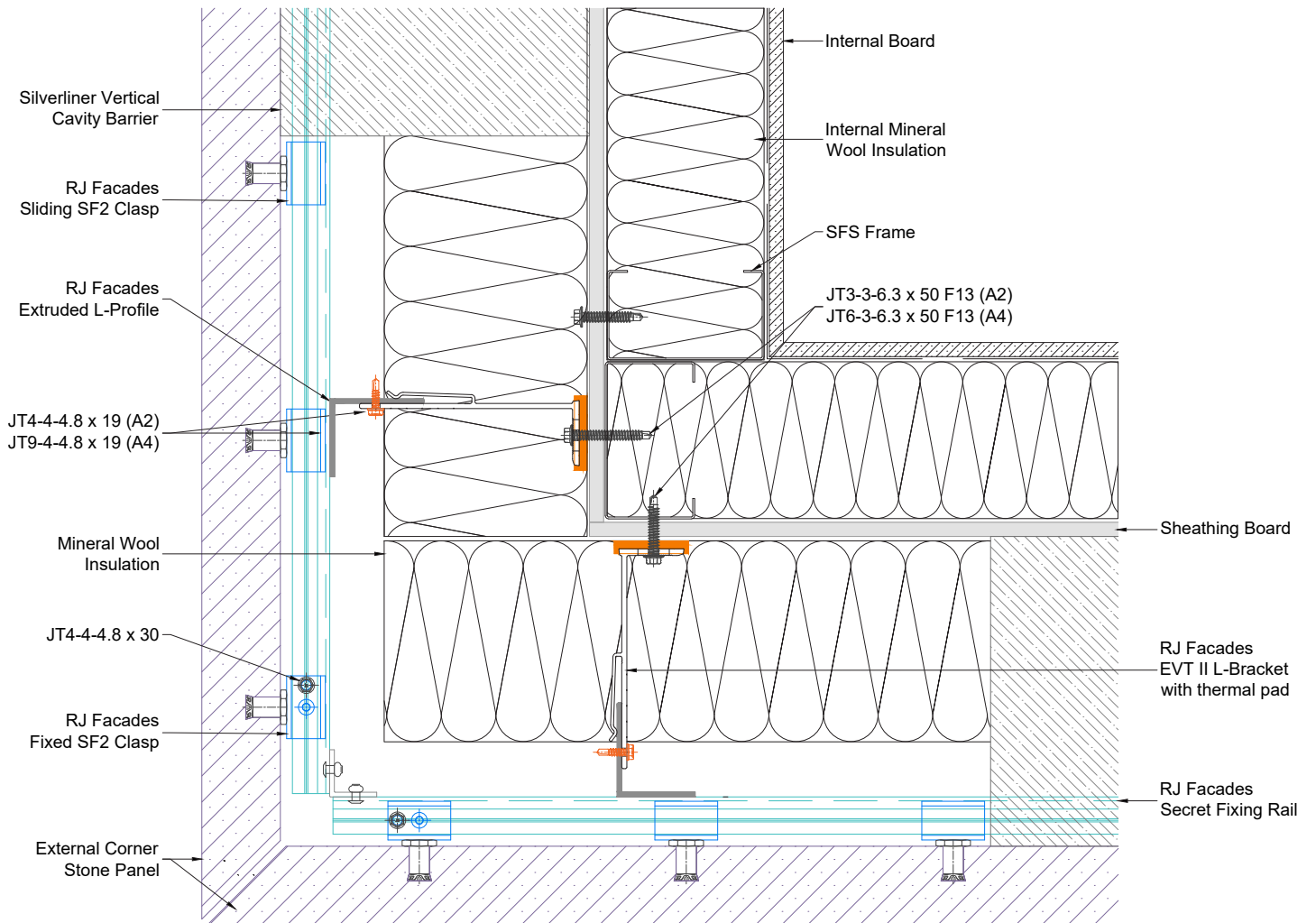

Secret Fix-H

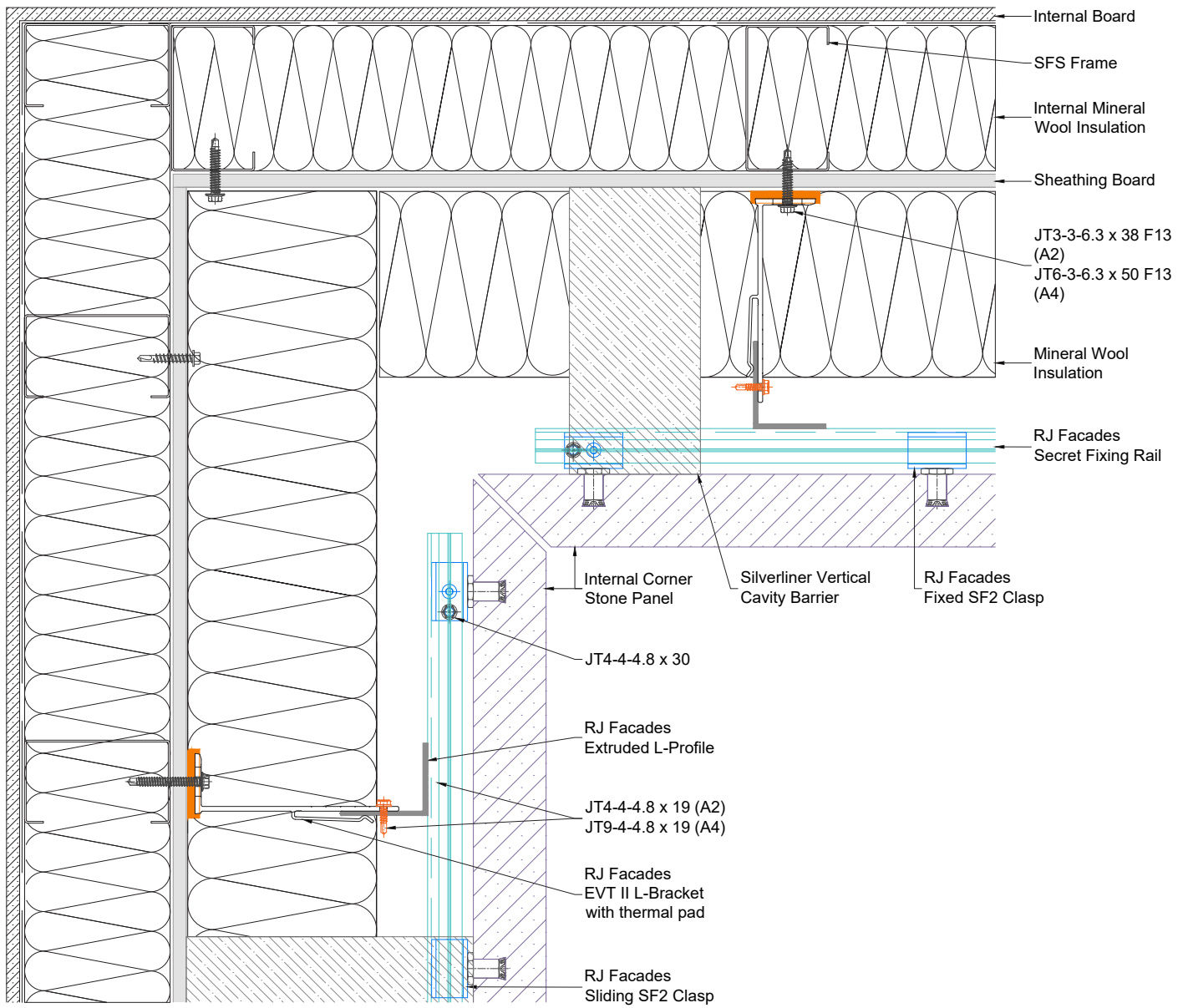

Secret Fix-H

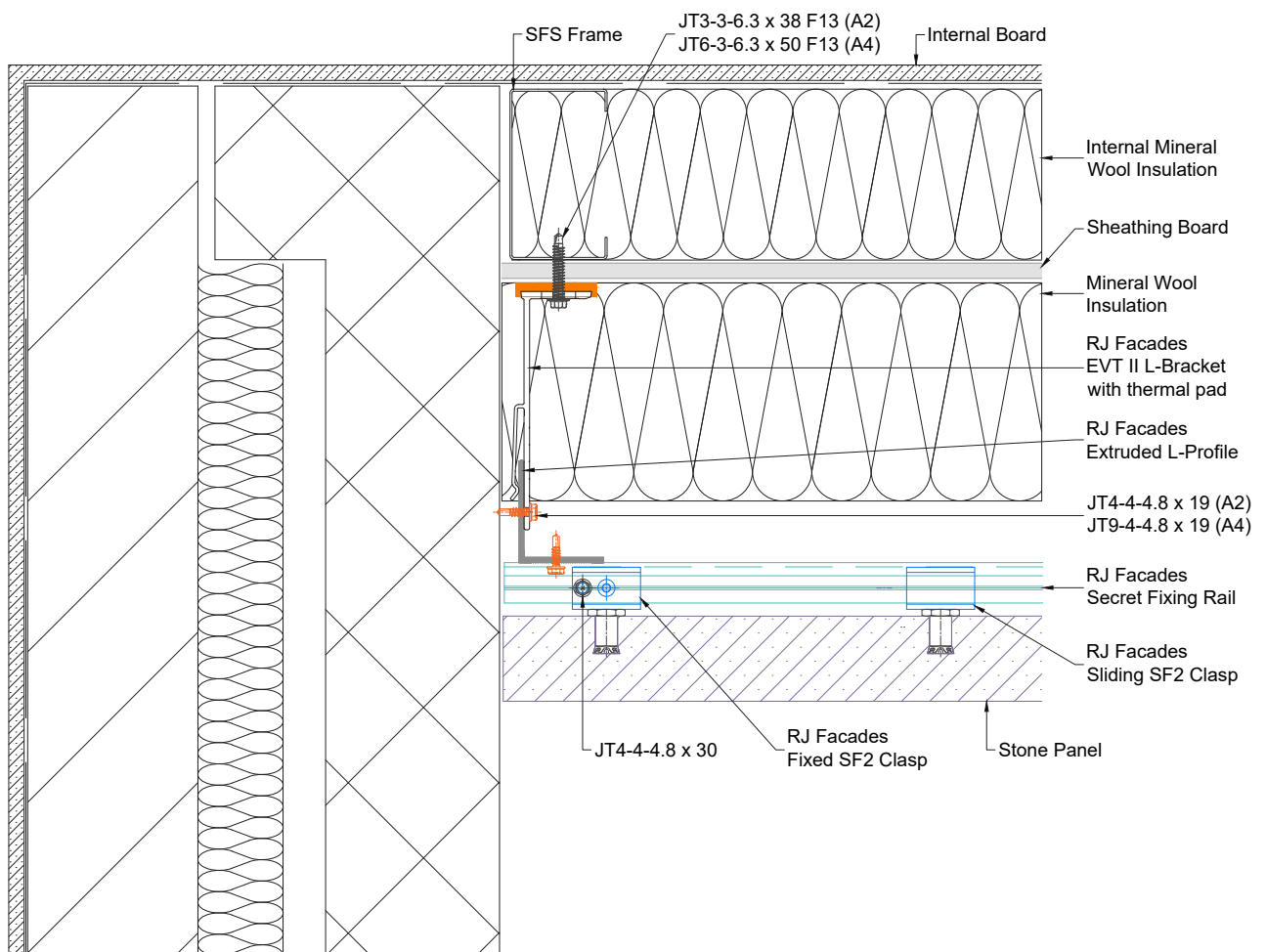

Secret Fix-H

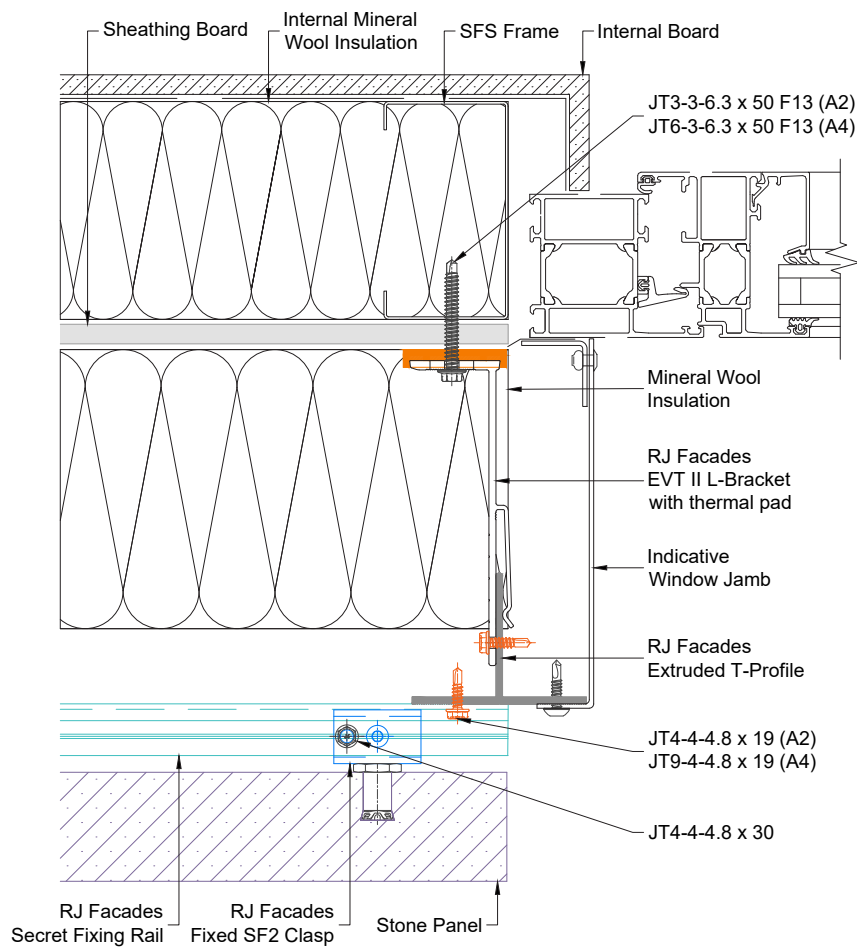

Secret Fix-H

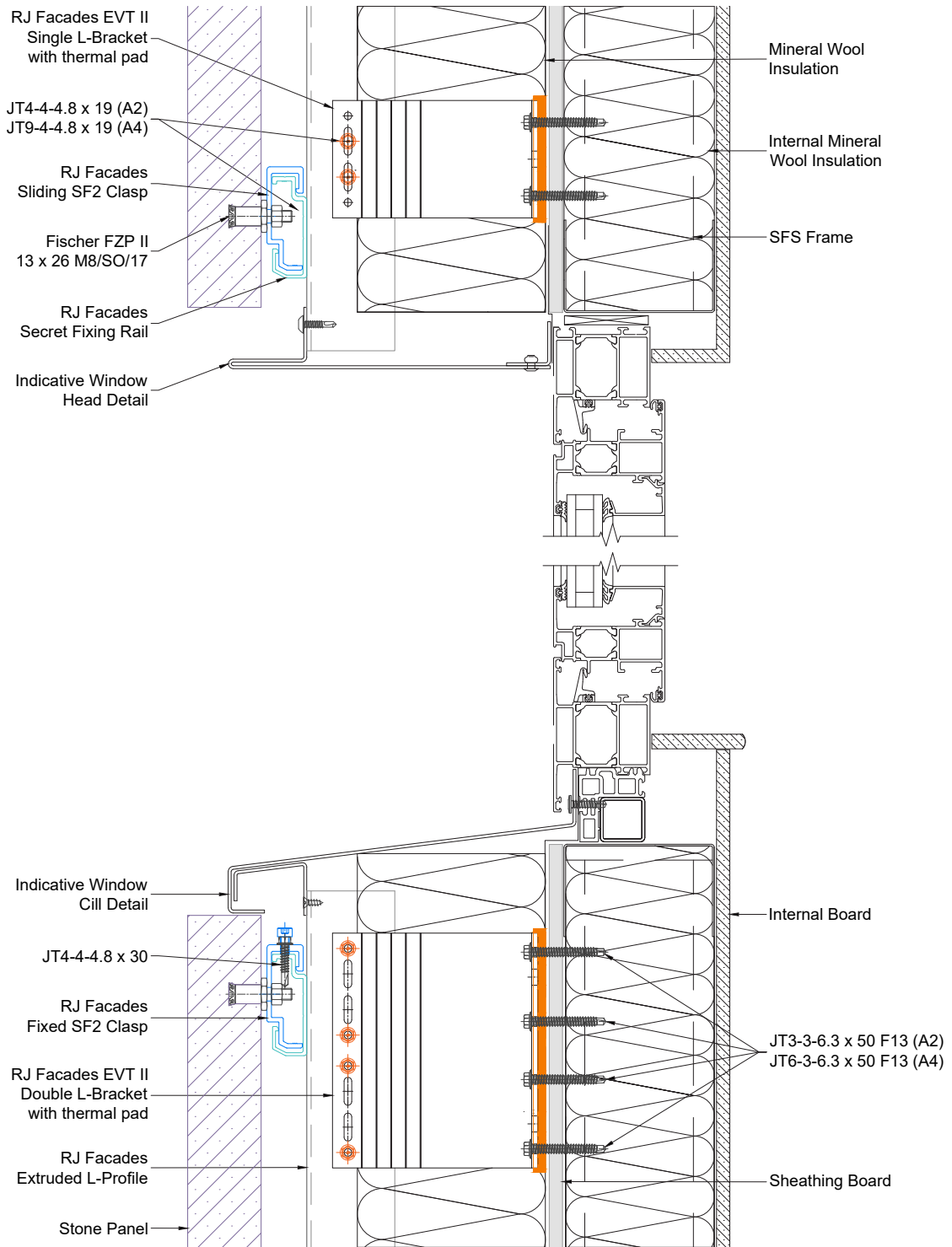

Secret Fix-H

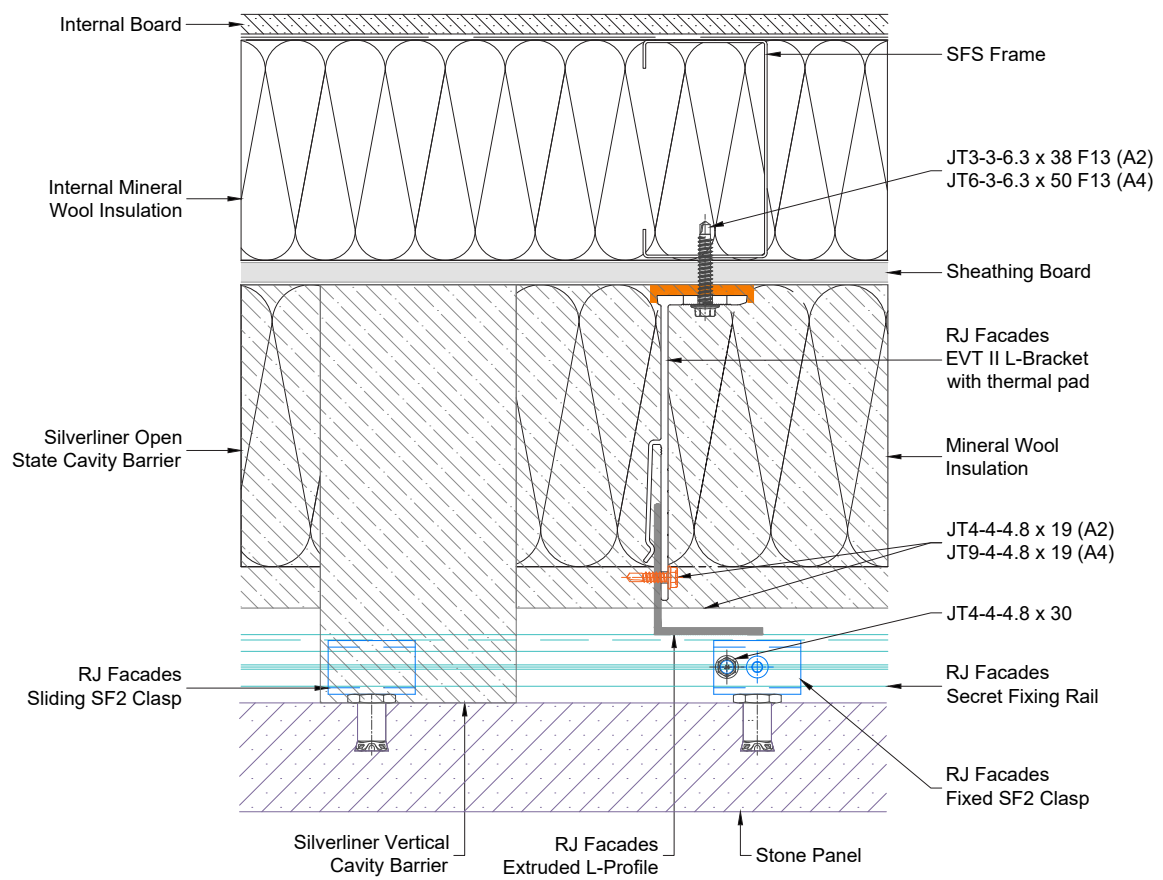

Facade Designer

RJ Facade Designer

For each calculation of new projects by RJ Facades, it is necessary for a project checklist form to be filled. It includes detailed information, which helps customers to receive the most accurate and precise offer. The offers may vary depending on the cladding/facade material; the dimensions and weight of the material; wind load; floor heights; thickness of thermal insulation; structural base; raster of the facades; fixing methods; and different ventilated facade systems. In order to achieve a qualitative calculation, it is necessary for the drawings to be submitted via email/ courier in CAD format. If there are any specific features of the project, these are also taken into consideration.

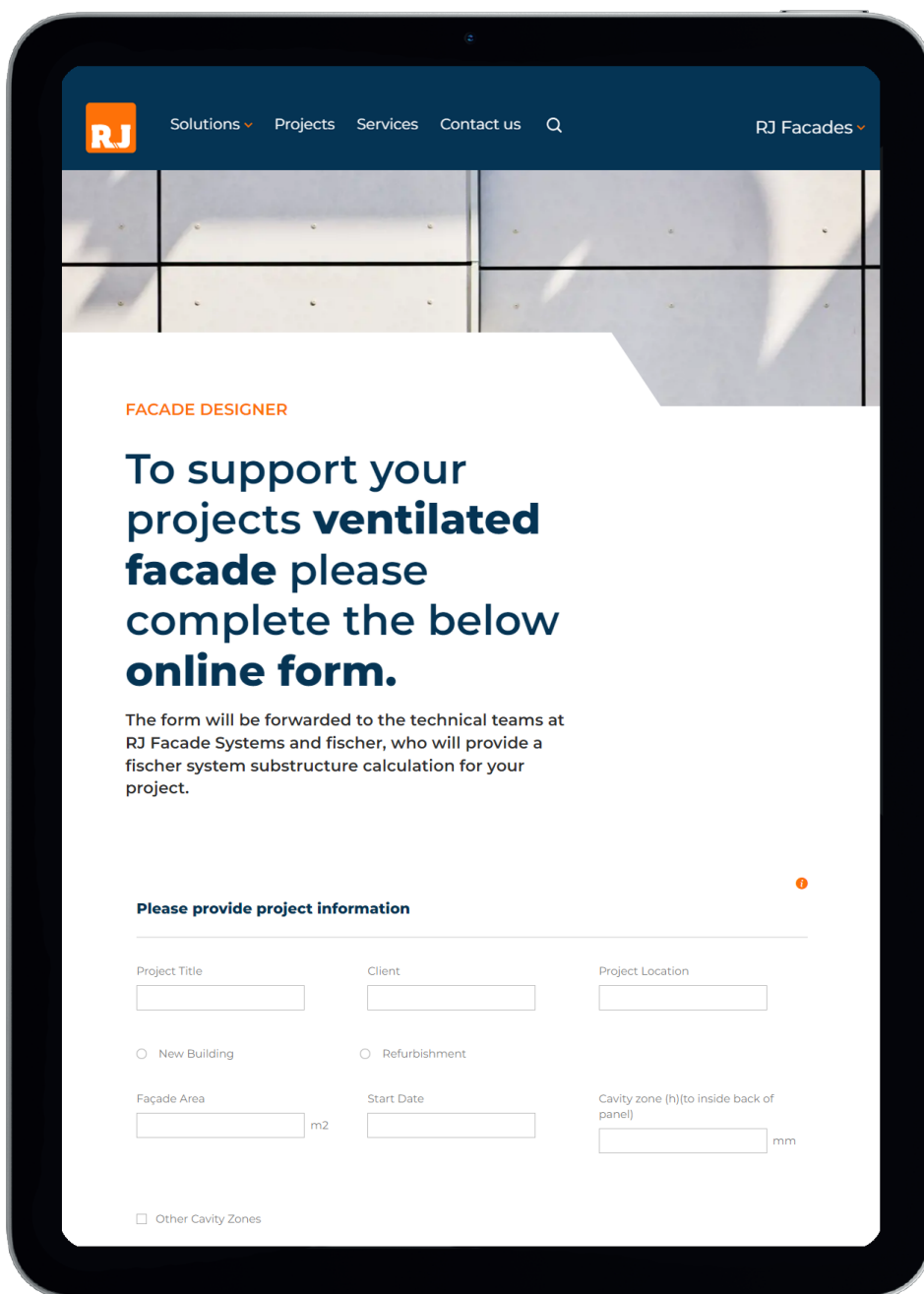

Standards & liability

Standards

General

EN 12020 (1÷2) - Aluminium and aluminium alloys - Extruded precision profiles in alloys EN AW-6060 and EN AW-6063

EN 755 (1÷9) - Aluminium and aluminium alloys - Extruded rod/bar, tube and profiles

EN 573 (1÷3) - Aluminium and aluminium alloys - Chemical composition and form of wrought products

EN 15088 - Aluminium and aluminium alloys - Structural products for construction works - Technical conditions for inspection and delivery

EN 1990 Eurocode - Basis of structural design

EN 1991 Eurocode 1 - Actions on structures

EN 1998 Eurocode 8 - Design of structures for earthquake resistance

EN 1999 Eurocode 9 - Design of aluminium structures

Ventilated facade systems

ETAG 034, part 1 - Kits for external wall claddings, Part I: Ventilated cladding kits comprising cladding components and associated fixings

ETAG 034, part 2 - Kits for external wall claddings, Part II: Cladding kits comprising cladding components, associated fixings, subframe and possible insulation layer

CWCT Standard for Systemized Building Envelopes

EN 13830 - Curtain walling - Product standard

EN ISO 6946 - Building components and building elements - Thermal resistance and thermal transmittance - Calculation method

EN ISO 10211 - Thermal bridges in building construction - Heat flows and surface temperatures - Detailed calculations EN

ISO 14683 - Thermal bridges in building construction - Linear thermal transmittance - Simplified methods and default values

EN 13116 - Curtain walling - Resistance to wind load - Performance requirements

EN 12179 - Curtain walling - Resistance to wind load - Test method

EN 14019 - Curtain Walling - Impact resistance - Performance requirements

EN ISO 10140 - Acoustics - Laboratory measurement of sound insulation of building elements

EN 20140 - Acoustics - Measurement of sound insulation in buildings and of building elements

EN ISO 717-1 - Acoustics - Rating of sound insulation in buildings and of building elements - Part 1: Airborne sound insulation

Liability

The stated data and calculating methods are provided by RJ Facades as a guideline only.

The information given in this catalogue does not substitute all applicable regulations – Eurocodes, harmonized European standard, national or regional building codes.

The specific conditions and technical details of every particular project have to be taken in consideration.

The right choice of all elements as well as any special requirements regarding stability of the structure must always be considered by the structural/facade engineer, responsible for the project.

The solution presented in these pages are indicative and cannot cover all possible project cases. Because of that every single project has to be evaluated by the structural/facade engineer in charge taking into consideration the specific features, such as climate conditions, location, orientation, etc.

RJ Facades is not liable for any calculation and conclusions made on the basis of the stated information. All calculations and specifications must be estimated, endorsed and guaranteed by architect, engineer, professional or legal entity authorized by law for such activities.

rjfacades.com

